

Custom Product Overview	P-2
MMCX Connectors	
Overview.....	P-3
Cabled.....	P-4 to P-5
PCB.....	P-5 to P-6
Edge Mount.....	P-7
MCX Connectors	
Overview.....	P-8
Cabled.....	P-9
PCB.....	P-10 to P-12
Edge Mount.....	P-12
SMB Connectors	
Overview.....	P-13
Cabled.....	P-14
PCB.....	P-15
FAKRA/SMB	
Overview.....	P-16
Cabled.....	P-17 to P-18
PCB.....	P-19
Keying and Color Codes.....	P-20
SMA Connectors	
Overview.....	P-21
Cabled.....	P-22
PCB.....	P-23
Solder Pot.....	P-24
Tab Terminals.....	P-24 to P-25
Post Terminals.....	P-25 to P-26
Flange Mounts.....	P-26 to P-28
Brass Subminiature.....	P-28 to P-29
Stainless Steel Subminiature.....	P-29 to P-30
BNC Connectors	
Overview.....	P-31
Cabled.....	P-32
PCB.....	P-33 to P-37
50 Ohm.....	P-38 to P-40
50 and 75 Ohm.....	P-40
SMP Connectors	
Overview.....	P-41
PCB.....	P-42
Jack-to-Jack.....	P-42
Cabled.....	P-42 to P-43
Edge Mount.....	P-43
Surface Mount.....	P-43

Visit www.molex.com to access more part numbers and product information, download sales drawings, product specifications, 3D models, place sample requests, and more.

Molex Custom Product Overview



Features and Benefits

- Frequencies to 50GHz
- Special configurations, interfaces and sizes available
- Available at all volumes
- Non-magnetic versions available
- IP68 Bulkhead versions available
- Custom ganged solutions available

Molex RF/Microwave connectors include custom designs to meet the requirements of special applications. Most custom designs have standard interfaces, but they include feature(s) that result in a custom-designed product.

Some custom designs include unique mating interfaces. Special application custom connectors can be designed for a user's particular needs.

Contact either our US or Taiwan location to discuss your custom-designed product requirements with a Molex application engineer.

Molex RF Cable Assemblies



Features and Benefits

- 100% HiPot and Continuity
- Wide range of standard and custom connector interfaces
- Wide range of cable types
- 50 and 75 ohm designs
- Ganged and bundled solutions available
- Indoor and outdoor cable assemblies
- Customer specific testing available
- Standard and custom solutions

Molex RF offers cable assemblies ranging from standard traditional configurations to custom, ganged, and bundled customer specific cable assembly solutions.

With our large connector offering and responsive custom connector solutions, Molex RF has the solution for your cable assembly requirements.

Molex RF connector designs can accommodate standard RG braided cables, micro coax, semi-rigid cable, vendor specific custom cables, LMR types, and hand conformable cables.

MMCX Connectors

Overview

Molex MMCX connectors are a microminiature connector series designed for applications where densely-populated electronic packages demand size and weight limitations while maintaining good RF characteristics. MMCX connectors are designed to function in applications operating to 6 GHz and offer similar electrical performance to much larger coaxial connector types. Mechanical stability is maintained via a snap fit interface that uses no slotting in the outer conductor. Typical applications include wireless/PCS devices, telecommunications, GPS receivers and consumer electronics.

Features and Benefits

- Micro miniature
- Snap-on coupling
- DC to 6 GHz

Engineering

Nominal Impedance: 50 ohms
Frequency Range: DC-6 GHz

Mechanical

Force to Engage: Axial Force 15N (3.4 lb) max.
Force to Disengage: Axial Force 6N to 15N (1.4 to 3.4 lb)
Connector Durability: 500 Cycles
Center Contact Retention: Axial Force—10N (2.3 lb)
Cable Retention: Axial Force—32.7N (7.3 lb)

Engineering

Nominal Impedance	Frequency Range
50 ohms	DC-6 GHz

Mechanical

Force to Engage - Axial Force	Force to Disengage - Axial Force	Connector Durability	Center Contact Retention - Axial Force	Cable Retention
				Axial Force
25N (5.6 lb) max.	8N to 20N (1.8 to 4.5 lb)	500 cycles	10N (2.25 lb)	49.8N (11.2 lb)

Electrical

Voltage Rating: Sea Level	Insulation Resistance	Dielectric Withstanding Voltage	Contact Resistance		Voltage Standing Wave Ratio		RF Leakage	
			Center Contact Initial	Outer Contact	Cable RG178	Edge Mount	Cable	Edge Mount
170 Vrms	1000 Megohms	500 Vrms	5.0 milliohms	2.5 milliohms	1.12 at 6 GHz	1.12 at 6 GHz	60 dB	60 dB
					1.08 at 2.5 GHz	1.10 at 2.5 GHz		
					1.04 at 1 GHz	1.05 at 1 GHz		

Environmental

Vibration: MIL-STD-202, Method 204	Thermal Shock: MIL-STD-202, Method 107	Corrosion (Salt Spray): MIL-STD-202, Method 101	Moisture Resistance: MIL-STD-202, Method 106
Test Condition C	Test Condition F	Test Condition B	5 min after removal 200 Megohms

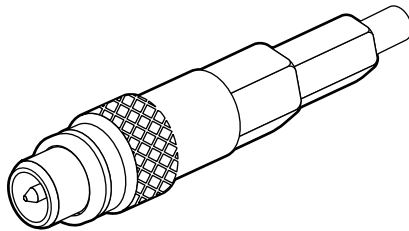

Straight Solder/Crimp Plug

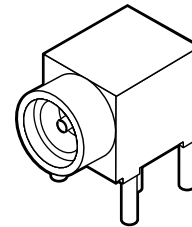

Right Angle PCB Jack Receptacle

MMCX Connectors

Plug

Straight

Crimp/Crimp

Cable

- Center contact crimp or solder termination
- Crimp braid termination
- Packaging: Individual

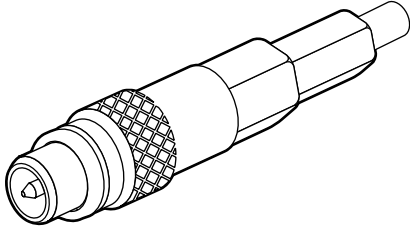

Order No.	Cable Group	Assembly Instructions	Lead-free
73415-0971	RG178, 196	AS-89678-0900	Yes
73415-1251	RG188, 174, 316	AS-89678-2700	
73415-2101	.086 semi-rigid	AS-89678-2800	
73415-2111	.047 semi-rigid	AS-89678-2900	
73415-2131	RD174, 188, 316	AS-89678-3000	
73415-3400	1.13mm	AS-73597-0140	

RF/Microwave Coaxial Products

MMCX Connectors

Plug

Right Angle

Solder/Crimp

Cable

- Center contact solder termination
- Crimp braid termination
- Packaging: Individual

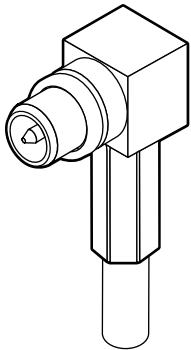

Order No.	Cable Group	Assembly Instructions	Lead-free
73415-0951	RG178, 196	AS-89678-0700	Yes
73415-1121	RG174, 188, 316 single shielded	AS-89678-1700	
73415-2141	RD174, 188, 316 double shielded	AS-89678-3100	
73415-2151	.047 semi-rigid	AS-89678-3200	
73415-2161	.086 semi-rigid	AS-89678-3300	
73415-2261	1.13mm	AS-73597-0160	

P

MMCX Microminiature Connectors

Straight Crimp Jack

- Packaging: Individual
- Small size

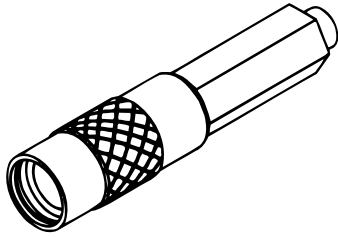

Order No.	Cable Group	Assembly Instructions	Body	Plating
73415-3410	1.13mm	AS-73597-0130	Brass	Gold
73415-3210	RG178, 196	AS-89678-6900		

MMCX Connectors

Vertical PCB Plug

- Packaging: Individual
- Small size

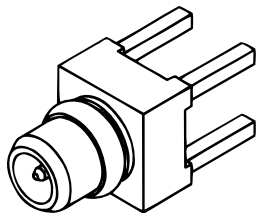

Order No.	Body	Plating
73415-2121	Brass	Gold

MMCX Connectors

Vertical PCB Jack Receptacle

- Packaging: Individual
- Small size

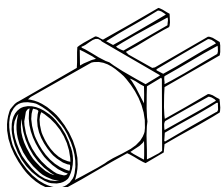

Order No.	Body	Plating
73415-1471	Brass	Gold

MMCX Microminiature Connectors

Surface Mount Jack Receptacle

- Packaging: Individual or tape and reel
- Small size

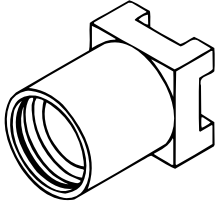

Order No.	Body	Plating
73415-2061	Brass	Gold
73415-2063*		

* Tape and reel

MMCX Connectors Jack Receptacle Right Angle PCB

- Body: Brass
- Overall Plating: Gold
- Packaging: Individual
- One-piece body

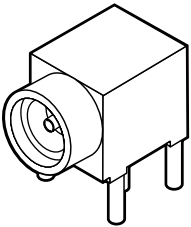

Order No.	Lead-free
73415-1001	Yes

MMCX Connectors Plug Edge Mount

- Body: Brass
- Overall Plating: Gold
- Packaging: Individual

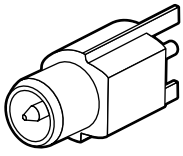

Order No.	Lead-free
73415-0991	Yes

MMCX Connectors Jack Receptacle Edge Mount

- Body: Brass
- Overall Plating: Gold
- Packaging: Individual

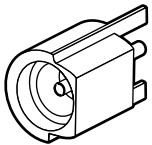

Order No.	Lead-free
73415-0963	Yes

MCX Connectors

Overview

Molex MCX connectors are a subminiature snap-on connector offering a stable and durable connection while allowing electronic assemblies to be more densely packaged than other subminiature series. MCX connectors are approximately 30% smaller than SMB type connectors but use the same proven internal interconnect arrangement with respect to the dielectric and center contact. The MCX series provides good electrical performance to 6 GHz and is used in telecommunication systems as well as wireless and GPS applications.

Features and Benefits

- Subminiature
- Snap-on coupling
- DC to 6 GHz
- 30% smaller than SMB

Engineering

Nominal Impedance: 50 ohms
 Frequency Range: DC-6 GHz
 Voltage Rating: Sea Level—335 Vrms

Mechanical

Force to Engage: Axial Force 25N (5.6 lb) max.
 Force to Disengage: Axial Force 8N to 20N (1.8 to 4.5 lb)
 Connector Durability: 500 Cycles
 Center Contact Retention: Axial Force—10N (2.25 lb)
 Cable Retention: Axial Force—49.8N (11.2 lb)

Engineering

Nominal Impedance	Frequency Range	Voltage Rating - Sea Level
50 ohms	DC-6 GHz	335 Vrms

Mechanical

Force to Engage - Axial Force	Force to Disengage - Axial Force	Connector Durability	Center Contact Retention - Axial Force	Cable Retention
				Axial Force
25N (5.6 lb) max.	8N to 20N (1.8 to 4.5 lb)	500 cycles	10N (2.25 lb)	49.8N (11.2 lb)

Electrical

Voltage Rating: Sea Level	Insulation Resistance	Dielectric Withstanding Voltage	Contact Resistance				Voltage Standing Wave Ratio	
			Center Contact Initial	Outer Contact After Environment	Outer Contact	Outer Cable Conductor to Body	Straight	Right Angle
335 vrms	10,000 Megohms min.	1000 Vrms min.	5.0 milliohms max.	15 milliohms max.	2.5 milliohms max.	7.5 milliohms max.	1.30 max. DC-2 GHz 1.35 max. 2-6 GHz	1.50 DC-2 GHz 1.65 max. 2 to 6 GHz

Environmental

Vibration: MIL-STD-202, Method 204	Thermal Shock: MIL-STD-202, Method 107	Corrosion (Salt Spray): MIL-STD-202, Method 101	Mechanical Shock: MIL-STD-202, Method 213	Moisture Resistance: MIL-STD-202, Method 106
Test Condition A	Test Condition A	Test Condition B	Test Condition A	5 minutes after removal, 200 Megohms

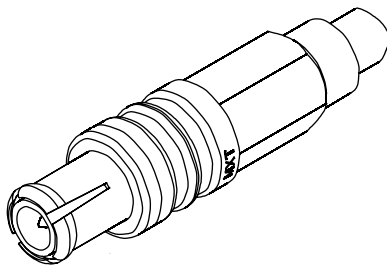

Straight Solder/Crimp Plug

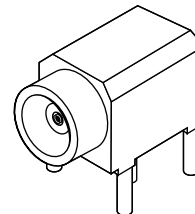

Right Angle PCB Jack Receptacle

MCX Connectors Plug Straight Solder/Crimp

- Overall Plating: Nickel
- Center contact solder termination
- Packaging: Tray

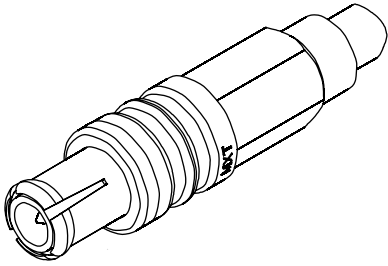

Order No.	Cable Group	Assembly Instructions	Plating	Lead-free
73366-0020	RG174, 179, 187, 188, 316	AS-73392-006	Nickel	Yes
73415-2240	RD316	AS-89678-2600	Gold	
73415-2370	.086 SR	AS-89678-8550		

MCX Connectors Plug Right Angle Solder/Crimp

- Center contact solder termination
- Packaging: Tray

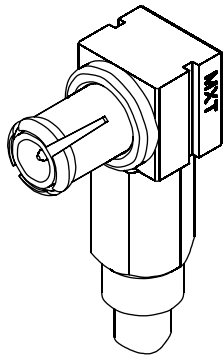

Order No.	Cable Group	Assembly Instructions	Body	Plating	Lead-free
73366-0010	RG174, 179, 187, 188, 316	AS-73392-005	Diecast	Nickel	Yes
73415-1050	RG178, 196	AS-89678-1000			
73415-2230	RD316	AS-89678-2500	Brass	Gold	
73415-2381	.086 SR	AS-89678-3500			
73415-2460	.141 SR	AS-89678-4200			

MCX Connectors Jack Receptacle Vertical PCB

- Overall Plating: Nickel or Gold
- Body: Brass
- Packaging: Tray

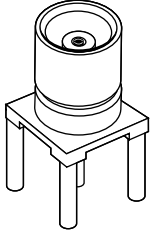

Order No.	Body	Plating	Lead-free
73366-0000	Diecast	Nickel	Yes
73366-0060	1-piece Brass		
73366-0061		Gold	
73366-4220			

RF/Microwave Coaxial Products

MCX Connectors Jack Receptacle Vertical Bulkhead Mount PCB

- Body: Brass
- Overall Plating: Gold

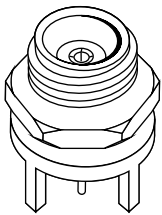

Order No.	Lead-free
73415-1040	Yes

P

MCX 50 Ohm Subminiature Snap-on Connectors

- Packaging: Tray or tape and reel

Vertical Surface Mount Jack Receptacle

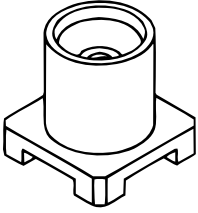

Order No.	Body	Plating
73415-1690	Brass	Nickel
73415-1691		Gold
73415-1692*		

* Tape and reel

MCX 50 Ohm Subminiature Snap-on Connectors

- Packaging: Tray

Right Angle Surface Mount Jack Receptacle

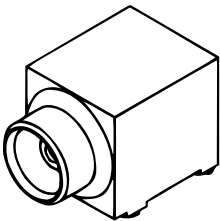

Order No.	Body	Plating
73415-1100	Brass/Zinc Alloy	Nickel/Tin

MCX Connectors Jack Receptacle Right Angle PCB

- Body: Brass
- Overall Plating: Nickel

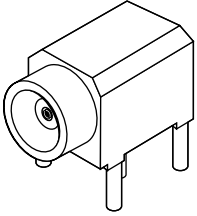

Order No.	Lead-free
73366-0030	Yes

RF/Microwave Coaxial Products

MCX Connectors Jack Receptacle Edge Mount

- Body: Brass
- Overall Plating: Gold
- Tape and reel packaging

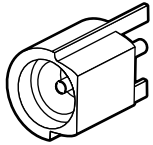

Order No.	Lead-free
73415-1060	Yes

P

SMB Connectors

Molex SMB connectors are a subminiature connector series designed for applications operating to 4 GHz. This series includes a snap-on interface that is controlled by industry standard specifications and is easy to connect and disconnect. Mechanical stability is provided by the SMB interface, and its relatively small size allows it to be used in applications where space is limited. Each 50 ohm product has a mini 75 ohm SMB counterpart which has the same external envelope as the 50 ohm product. Applications for 50 ohm product include telecommunications equipment, instrumentation and commercial broadcast equipment. The mini 75 ohm SMB products are typically used in data and video transmission equipment.

Features and Benefits

- Subminiature
- Snap-on coupling
- DC to 4 GHz
- 50 and 75 ohms

Engineering

Nominal Impedance	Frequency Range	Voltage Rating - Sea Level	Temperature
50 ohms	DC-4 GHz	500 Vrms	-65 to +165°C
75 ohms			

Mechanical

Nominal Impedance	Force to Engage - Axial Force	Force to Disengage - Axial Force	Durability	Center Contact Retention - Axial Force	Cable Retention			
					Crimp		Non-Crimp	
					Cable OD	Minimum Axial Force	Cable OD	Minimal Axial Force
50 ohms	62.2N (14 lb) max.	8.9N to 62.2N (2 to 14 lb)	500 cycles	17.8N (4 lb) min.	<.154 (3.93)	22N (5 lb)		177.8N (40 lb)
75 ohms					.155 (3.94) to .188 (4.80)	44N (10 lb)		
					.189 (4.81) to .229 (5.82)	88.9N (20 lb)		
					.230 (5.83) to .249 (6.33)	133.3N (30 lb)		
					>.250 (6.34)	177.8N (40 lb)		

Electrical

Nominal Impedance	Insulation Resistance	Dielectric Withstanding Voltage	Contact Resistance		Voltage Standing Wave Ratio
			Center Contact Initial	Outer Contact	
50 ohms	1000 Megohms	1000 Vrms min.	6.0 milliohms max.	4.0 milliohms max.	1.30 + .001 fGHz per mated pair from DC to 4GHz
75 ohms				3.0 milliohms max.	

Environmental

Nominal Impedance	Vibration: MIL-STD-202, Method 204	Thermal Shock: MIL-STD-202, Method 107	Corrosion (Salt Spray): MIL-STD-202, Method 101	Mechanical Shock: MIL-STD-202, Method 213	Moisture Resistance: MIL-STD-202, Method 106
50 ohms	Test Condition B	Test Condition A	Test Condition B	Test Condition A	200 Megohms
75 ohms					

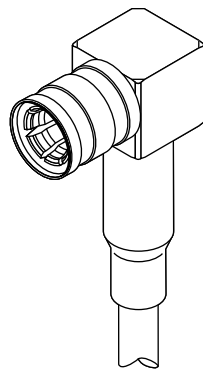

Right Angle Solder/Crimp Plug

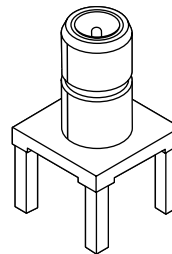

Vertical PCB Jack Receptacle

SMB Connectors Plug Solder/Crimp

- Overall Plating: Gold
- Packaging: Individual
- Center contact termination: See table

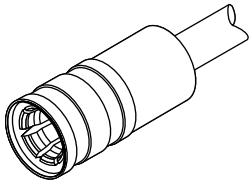

Order No.	Cable Group	Center Contact Termination	Impedance	Assembly Instructions	Body	Lead-free
73100-0248	RG174, 187, 188, 316	Solder	50 ohms	AS-73597-0054	Brass	Yes
73100-0255	RG179	Solder or Crimp	75 ohms Mini-SMB	AS-73597-0071		
73404-1861	RG179	Solder	75 ohms air-dielectric	AS-89511-0200		

SMB Connectors Plug Right Angle Solder/Crimp

- Overall Plating: Gold
- Center contact solder termination
- Crimp braid termination
- Packaging: Individual

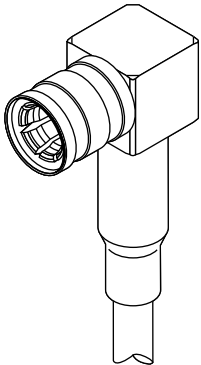

Order No.	Cable Group	Impedance	Assembly Instructions	Lead-free
73100-0257	RG174, 188, 316	50 ohms	AS-73597-0063	Yes
73100-0256	RG179	75 ohms Mini-SMB	AS-73597-0047	
73404-1730	RG178	50 ohms	AS-89678-8540	
73404-0430	RG179	75 ohms air-dielectric	AS-89678-8540	

SMB 50 Ohm Subminiature Connectors

- PCB standoffs
- Packaging: Tray

Right Angle
Bulkhead
PCB
Jack Receptacle

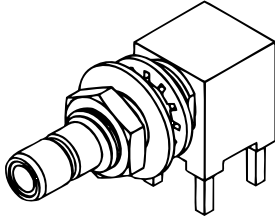

Order No.	Body	Plating
73100-0097	Brass	Gold

SMB Connectors Jack Receptacle Vertical PCB

- Overall Plating: Gold
- Body: Brass
- PCB Standoffs
- Packaging: Tray

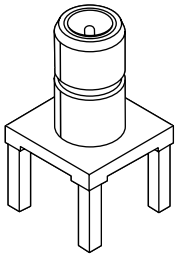

Order No.	Impedance	Lead-free
73100-0207	50 ohms	Yes
73100-0157	75 ohms Mini-SMB	
73404-1630	50 ohms	
73404-0390	75 ohms air-dielectric	

SMB Connectors Jack Receptacle Right Angle PCB

- Overall Plating: Gold
- Body: Brass
- PCB Standoffs
- Packaging: Tray

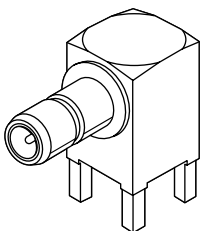

Order No.	Impedance	Lead-free
73100-0103	50 ohms	Yes
73100-0259	75 ohms Mini-SMB	
73404-0380	75 ohms air-dielectric	

FAKRA/SMB 50 Ohm Subminiature Connectors

PCB
Cable
Panel Mount
12 Keys

Features and Benefits

- Color-coded and keyed shrouds
- Designed for automotive telematic applications
- Low cost, high performance
- Withstands solder reflow temperatures with shroud installed

FAKRA SMB connectors are utilized by the automotive industries in the U.S. and Europe. Their application is key to on-board telematics and RF communication in today's automobiles.

This series uses an SMB interface with keyed and color-coded housings for ease in identification.

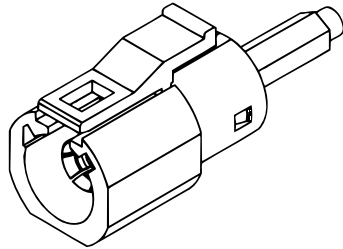

Plug

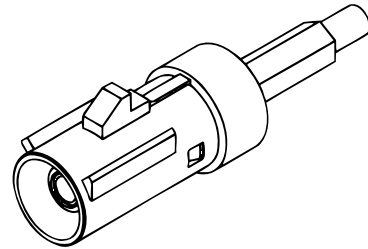

Jack

Typical Specifications

Electrical

Nominal Impedance (Ohms)	Frequency Range (GHz)	Voltage, Working (Vrms)	Insulation Resistance (Megohms)	Center Contact Resistance (milliohms)	Outer Contact Resistance (milliohms)	RF Leakage (-dB)	RF Insertion Loss (dB)	VSWR at Max. Freq
50	DC- 4	335	5000	6	1	-50 at 1GHz	≤ .2 at 4GHz	1.3 max

Mechanical

Coupling Method	Force to Engage (max)	Force to Disengage*	Durability (Cycles)
Snap	9 lbs	8 lbs	100

* With latch disengaged

Environmental

Temperature (Degrees C)	Vibration: MIL-STD-202, Method 204	Thermal Shock: MIL-STD- 202, Method 107	Corrosion (Salt Spray): MIL-STD-202, Method 101	Mechanical Shock: MIL-STD-202, Method 213	Moisture Resistance: MIL-STD-202, Method 106
-65 to +100 +125 for PCB [†]	Test Condition B	Test Condition B	Test Condition B	Test Condition B	Five minutes after removal 200 Megohms

[†] 30 seconds

FAKRA/SMB 50 Ohm Subminiature Connectors

- Color-coded and keyed
- Body: Zinc alloy
- Plating: Nickel
- Cable: RG174, 188, 316

Plug
Straight
Crimp
Keyed

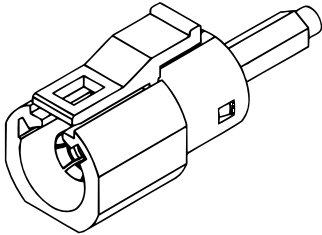

Part No.	Body	Color	Assembly Instruction
73415-2920	Z	Water blue	AS-89678-6800
73415-2919	K	Curry yellow	
73415-2918	I	Beige	
73415-2917	H	Violet	
73415-2916	G	Gray	
73415-2915	F	Brown	
73415-2914	E	Green	
73415-2913	D	Bordeauxviolet	
73415-2912	C	Blue	
73415-2911	B	Signal white	
73415-2910	A	Black	

Note: See page P-51 for keying information

FAKRA/SMB 50 Ohm

- Color-coded and keyed
- Body: Zinc Alloy
- Plating: Nickel
- Cable: RG58

Plug
Straight
Crimp
Keyed

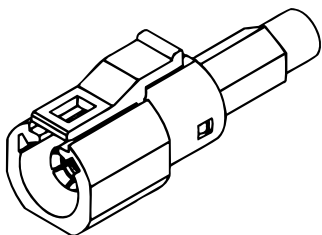

Part No.	Body	Color	Assembly Instruction
73404-0550	Z	Water blue	AS-89678-7400
73404-0549	K	Curry yellow	
73404-0548	I	Beige	
73404-0547	H	Violet	
73404-0546	G	Gray	
73404-0545	F	Brown	
73404-0544	E	Green	
73404-0543	D	Bordeauxviolet	
73404-0542	C	Blue	
73404-0541	B	Signal white	
73404-0540	A	Black	

Note: See page P-51 for keying information

FAKRA/SMB 50 Ohm Subminiature Connectors

- Color-coded and keyed
- Body: Zinc Alloy
- Plating: Nickel
- Cable: RG58

Jack
Straight
Crimp
Keyed

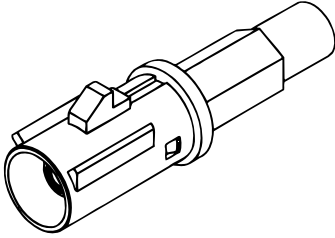

Part No.	Body	Color	Assembly Instruction
73404-0580	Z	Water blue	AS-89678-7500
73404-0579	K	Curry yellow	
73404-0578	I	Beige	
73404-0577	H	Violet	
73404-0576	G	Gray	
73404-0575	F	Brown	
73404-0574	E	Green	
73404-0573	D	Bordeauxviolet	
73404-0572	C	Blue	
73404-0571	B	Signal white	
73404-0570	A	Black	

Note: See page P-23 for keying information

FAKRA/SMB 50 Ohm

- Color-coded and keyed
- Body: Zinc Alloy
- Plating: Nickel
- Cable: RG316

Jack
Straight
Bulkhead
Keyed

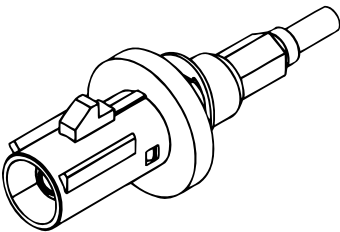

Part No.	Body	Color	Assembly Instruction
73404-1250	Z	Water blue	AS-89678-5600
73404-1249	K	Curry yellow	
73404-1248	I	Beige	
73404-1247	H	Violet	
73404-1246	G	Gray	
73404-1245	F	Brown	
73404-1244	E	Green	
73404-1243	D	Bordeauxviolet	
73404-1242	C	Blue	
73404-1241	B	Signal white	
73404-1240	A	Black	

Note: See page P-23 for keying information

FAKRA/SMB 50 Ohm Subminiature Connectors

- Color-coded and keyed
- Body: Zinc Alloy
- Plating: Tin
- Packaging: Tray
- 1-piece Diecast body and shroud

Jack Receptacle
Right Angle
PCB
Keyed

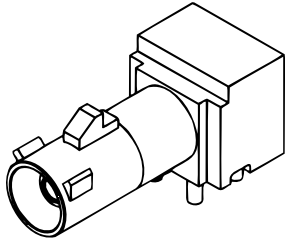

Part No.	Body	Color
73404-1060	A	Black
73404-1061	B	Signal white
73404-1062	C	Blue
73404-1063	D	Bordeaux violet
73404-1064	E	Green
73404-1065	F	Brown
73404-1066	G	Gray
73404-1067	H	Violet
73404-1068	I	Beige
73404-1069	K	Curry yellow
73404-1070	Z	Water blue
73404-1071	L	Carmine red
73404-1072	M	Pastel orange
73404-1073	N	Pastel green

Note: See page P-41 for keying information

FAKRA/SMB 50 Ohm Subminiature Connectors

Plug Keying and Color Code

Body	Color
A	Black
B	Signal white
C	Blue
D	Bordeaux violet
E	Green
F	Brown
G	Gray
H	Violet
I	Beige
K	Curry yellow
L	Carmine red
M	Pastel orange
N	Pastel green
Z	Water blue

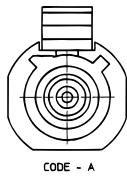

CODE - A

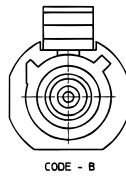

CODE - B

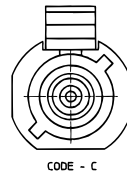

CODE - C

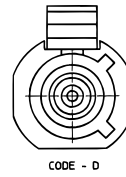

CODE - D

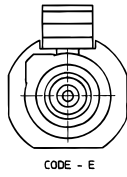

CODE - E

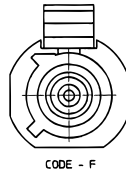

CODE - F

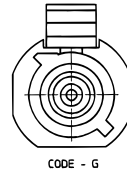

CODE - G

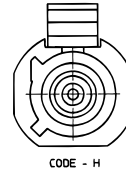

CODE - H

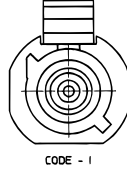

CODE - I

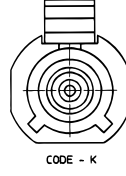

CODE - K

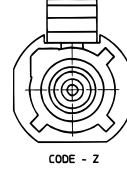

CODE - Z

FAKRA/SMB 50 Ohm

Jack Jack Receptacle Keying and Color Code



CODE - A



CODE - B



CODE - C

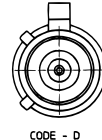

CODE - D

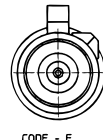

CODE - E



CODE - F

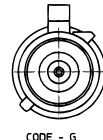

CODE - G



CODE - H



CODE - I



CODE - K

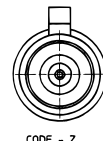

CODE - Z

Body	Color
Z	Water blue
K	Curry yellow
I	Beige
H	Violet
G	Gray
F	Brown
E	Green
D	Bordeauxviolet
C	Blue
B	Signal white
A	Black

SMA Connectors

Molex SMA connectors are high-performance subminiature connectors for microwave frequencies. These connectors are typically specified to operate up to 18 GHz but will function mode free to 25 GHz and some SMA connectors have been designed to operate to 27 GHz.

The screw-threaded coupling insures uniform contact of the outer conductors, which enables the SMA to minimize reflections and attenuation at higher frequencies while providing a high degree of mechanical strength and durability. In addition, when combined with the screw-threaded coupling, the SMA interface is designed to keep reactances to a minimum, which allows the SMA to be used beyond the frequencies associated with snap-on subminiature connectors.

Typical applications for SMA connectors include microwave active and passive components, instrumentation, avionics, and other high-end radio electronics.

Features and Dimensions

- Subminiature
- Threaded coupling
- DC to 27 GHz

Engineering

	Nominal Impedance	Frequency Range	Voltage Rating - Sea Level	Temperature
Cabled	50 ohms	DC-18 GHz	335 Vrms	-65 to +165° C
Non-Cabled		Cable Limited		

Mechanical

	Recommended Mating Torque	Force to Engage and Disengage - Radial	Coupling Nut Retention Force	Coupling Proof Torque	Mating Characteristics	Connector Durability	Center Contact Retention	Cable Retention
							Axial Force	Axial Force
Cabled	31N to 44.4N (7 to 10 in.-lb)	8.9N (2 in.-lb)	Plugs-266.6N (60 lb)	Plugs-1.7N-m (15 in.-lb)	See MIL-STD-348 Fig. 310-2 for Jacks Fig. 310-1 for Plugs	500 cycles	26.7N (6 lb)	133.3N (30 lb)
Non-Cabled								N/A

Electrical

	Insulation Resistance	Dielectric Withstanding Voltage	RF High Potential Withstanding	Contact Resistance				Voltage Standing Wave Ratio	RF Leakage	RF Insertion loss - dB max.
				Center Contact Initial	Center Contact After Environment	Outer Contact	Outer Conductor to Body			
Cabled	5000 Megohms	750 Vrms	500 Vrms at 5 MHz to 7.5 MHz	3.0 milliohms	4.0 milliohms	2.0 milliohms	5 milliohms	1.15 + .01fGHz	-60 dB min. 2 to 3 GHz	$.04 \sqrt{f(GHz)}$
Non-Cabled			670 Vrms at 5 MHz							N/A

Environmental

	Vibration: MIL-STD-202, Method 204	Shock: MIL-STD-202, Method 213	Thermal Shock: MIL-STD-202, Method 1071	Corrosion (Salt Spray): MIL-STD-202, Method 101	Moisture Resistance: MIL-STD-202, Method 106 5 min. after removal	Corona Level: 70,000 Feet
Cabled	Test Condition D	Test Condition I	Test Condition B	Test Condition B	200 Megohms	250 Vrms
Non-Cabled						

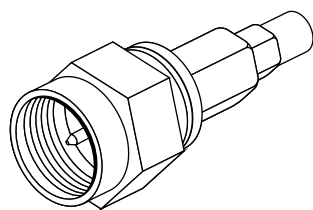

Straight Crimp/Crimp Plug

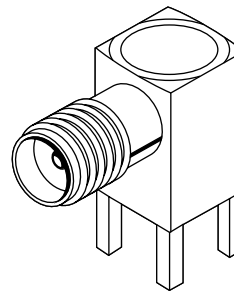

Right Angle PCB Jack Receptacle

SMA Connectors Plug Straight Crimp/Crimp

- Body: Stainless Steel, passivated or Brass
- Center contact crimp or solder termination
- Crimp braid termination
- Packaging: Individual

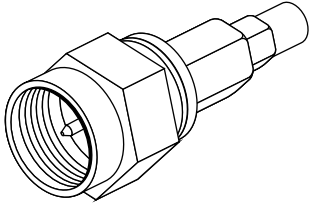

Order No.	Cable Group	Assembly Instructions	Body	Lead-free
73251-0151	RG174, 179, 187, 188, 316	ES-89675-1580	Stainless Steel	Yes
73251-0131	RG58, 141, 303	ES-89675-1570		
73251-0450	RG174, 179, 187, 188, 316	ES-89675-1580	Brass	
73251-3120	RG178, 196	See Sales Drawing		
73251-2931	LMR240			
73251-1630	LMR195			

SMA Connectors Plug Right Angle Solder/Crimp

- Body: Stainless Steel, passivated or Brass
- Center contact solder termination
- Crimp braid termination
- Packaging: Individual

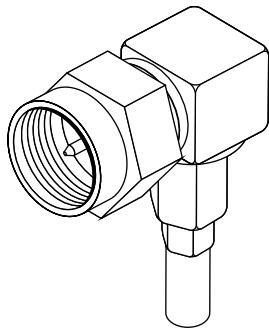

Order No.	Cable Group	Assembly Instructions	Body	Lead-free
73251-0211	RG174, 179, 187, 188, 316	ES-89675-1600	Stainless Steel	Yes
73251-0191	RG58, 141, 303	ES-89675-1590		
73391-0230	RG174, 179, 187, 188, 316	ES-89675-1600	Brass	
73251-0671	RG58, 141, 303	See Sales Drawing	Brass	

SMA Connectors Jack Receptacle Vertical PCB

- Overall Plating: Gold
- Body: Brass
- Packaging: Tray

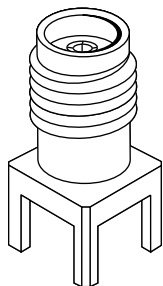

Order No.	With PCB Standoffs	Lead-free
73391-0060	73391-0070	Yes

SMA Connectors Jack Receptacle Right Angle PCB

- Overall Plating: Gold or Nickel
- Body: Brass or Diecast
- Packaging: Tray

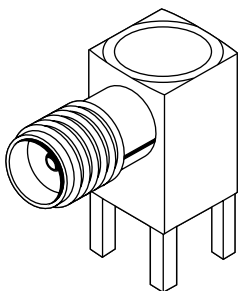

Order No.	Finish	Body	Lead-free
73100-0114	Gold	Brass	Yes
73100-0115	Nickel	Diecast	
73391-0080		Diecast Bulkhead	
73251-0081	Gold	Brass	
73251-2201	Gold	Brass	

SMA Connectors Jack Receptacle 4 Hole Flange Mount Solder Pot

- Overall Plating: Gold
- Body: Brass

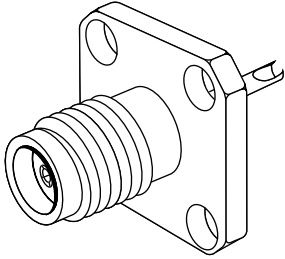

Order No.	Lead-free
73391-0040	Yes

RF/Microwave Coaxial Products

P

SMA Connectors Jack Receptacle 2 Hole Flange Mount Tab Terminal

- Body: Stainless Steel, passivated

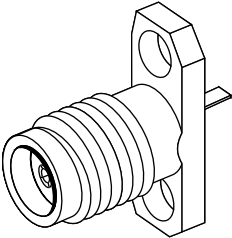

Order No.	Lead-free
73251-0280	Yes

SMA Connectors Jack Receptacle 4 Hole Flange Mount Tab Terminal

- Body: Stainless Steel, passivated

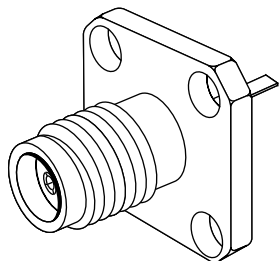

Order No.	Lead-free
73251-0270	Yes

SMA Connectors Jack Receptacle 2 Hole Flange Mount Extended Dielectric Post Terminal

- Body: Stainless Steel, passivated

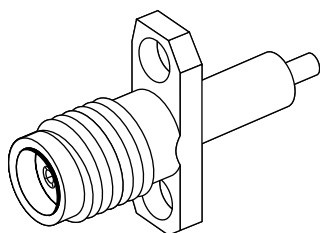

Order No.	Lead-free
73251-0420	Yes

SMA Connectors 4 Hole Flange Mount Extended Dielectric Post Terminal

- Body: Stainless Steel, passivated

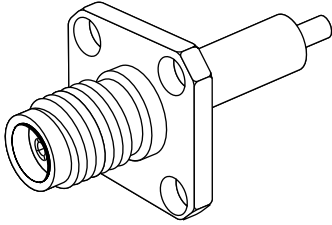

Order No.	Lead-free
73251-0040	Yes

RF/Microwave Coaxial Products

SMA Connectors Jack Receptacle Field Replaceable 2 Hole Flange Mount 27 GHz

- Body: Stainless Steel, passivated

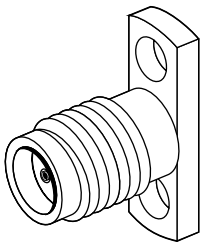

Order No.	Accepts Pin Diameter	Lead-free
73251-0200	.305 (0.012)	Yes
73251-0940	.381 (0.015)	
73251-0920	.457 (0.018)	
73251-0180	.508 (0.020)	

P

SMA Connectors Jack Receptacle 2 Hole Flange Mount 27 GHz

- Body: Stainless Steel, passivated

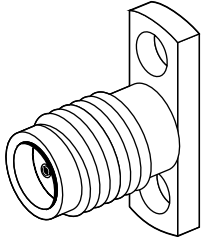

Order No.	Accepts Pin Diameter	Lead-free
73251-1020	.305 (0.012)	Yes
73251-1000	.381 (0.015)	
73251-0980	.457 (0.018)	
73251-0960	.508 (0.020)	

SMA Connectors Jack Receptacle Field Replaceable 4 Hole Flange Mount 27 GHz

- Body: Stainless Steel, passivated

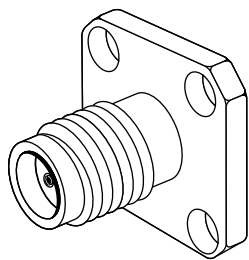

Order No.	Accepts Pin Diameter	Lead-free
73251-0160	.305 (0.012)	Yes
73251-0820	.381 (0.015)	
73251-0800	.457 (0.018)	
73251-0140	.508 (0.020)	

SMA Connectors Jack Receptacle 4 Hole Flange Mount 27 GHz

- Body: Stainless Steel, passivated

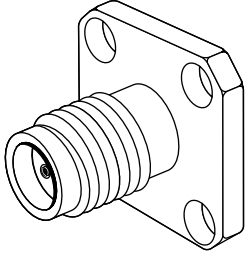

Order No.	Accepts Pin Diameter	Lead-free
73251-0900	.305 (0.012)	Yes
73251-0880	.381 (0.015)	
73251-0860	.457 (0.018)	
73251-0840	.508 (0.020)	

RF/Microwave Coaxial Products

SMA Brass Subminiature Connectors

- Crimp braid termination
- Packaging: Individual

Bulkhead Crimp Jack

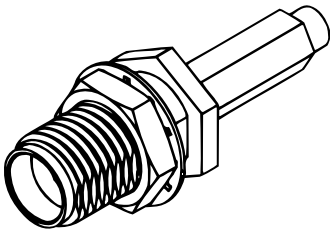

Order No.	Cable Group	Center Contact Termination	Plating	Assembly Instructions
73251-0930	RG174, 188, 316	Solder or crimp	Gold	ES-89675-1640
73251-1480	RG178			AS-89678-1480
73251-2171	RG174, 183, 316			See Sales Drawing

SMA Brass Subminiature Connectors

Edge Mount Jack Receptacle

- Mechanical captivation
- Packaging: Tray

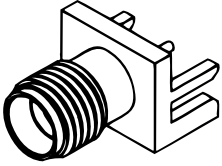

Order No.	Plating
73251-1150	Gold

SMA Stainless Steel Subminiature Connectors

Straight Solder Plug

- Solder termination
- Packaging: Individual

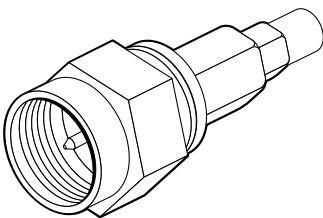

Order No.	Cable Group	Center Contact Termination	Plating	Assembly Instructions
73251-0031	.141 SR	Solder	Gold/Passivated	ES-89675-1520
73251-0051	.086 SR			
73251-3091	.047 SR			See Sales Drawing

SMA Stainless Steel Subminiature Connectors

- Solder termination
- Packaging: Individual

Straight Angle Solder Plug

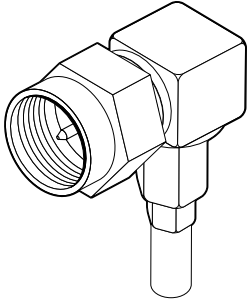

Order No.	Cable Group	Center Contact Termination	Plating	Assembly Instructions
73251-0071	.141 SR	Solder	Gold/Passivated	ES-89675-1540
73251-0091	.085 SR			

SMA Stainless Steel Subminiature Connectors

- Crimp braid termination
- Packaging: Individual

Bulkhead Jack

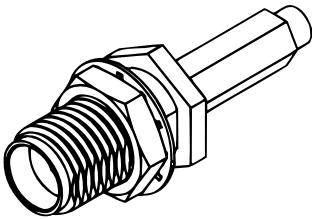

Order No.	Cable Group	Center Contact Termination	Plating	Assembly Instructions
73251-0100	R658, 141, 303	Solder or crimp	Passivated	ES-89675-1550
73251-0080	R655, 142			
73251-1960	RG174, 188, 316			AS-89678-8940

SMA Stainless Steel

- Mechanical captivation
- Packaging: Tray

Bulkhead Feed-through Jack Receptacle

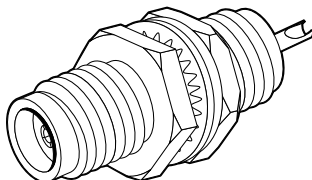

Order No.	Plating
73251-0260	Passivated

BNC Connectors

Molex BNC connectors are small, lightweight, weatherproof miniature connectors that are the most popular connector series used in a variety of RF applications. The two stud bayonet coupling system of the BNC yields an easy-to-use, quick connecting/disconnecting device that accounts for the BNC's popularity. These connectors are manufactured to MIL-PRF-39012 requirements and are typically used in applications operating up to 4 GHz. BNC connectors are used in data networking as well as video, audio and test equipment application. Video applications such as security systems use 75 ohm versions to match the standard system impedance.

Features and Dimensions

- Miniature
- Bayonet Lock Coupling
- DC to 4 GHz
- 50 and 75 ohms

Engineering

Nominal Impedance	Frequency Range	Voltage Rating - Sea Level	Temperature
50 ohms	DC-4 GHz	500 Vrms	-65 to +165°C
75 ohms			

Mechanical

Nominal Impedance	Force to Engage and Disengage		Coupling Nut Retention Force	Mating Characteristics	Durability	Center Contact Retention - Axial Force	Cable Retention - Axial Force
	Axial Force	Radial					
50 ohms	13.3N (3 lb)	28N-cm (2.5 in.-lb)	Plugs - 444N (100 lb)	SEE ES-73599-0000	500 cycles	26.7N (6 lb)	RG 174, 188, 316 - 44.4N (10 lb) RG 58, 141, 303 - 88.9N (20 lb) RG 59, 62 - 133.3N (30 lb)
75 ohms							

Electrical

Nominal Impedance	Insulation Resistance	Dielectric Withstanding Voltage	Contact Resistance			Voltage Standing Wave Ratio	RF Leakage	RF Insertion Loss
			Center Contact Initial	Center Contact After Environment	Outer Contact			
50 ohms	5000 Megohms	1500 Vrms min.	2.0 milliohms	2.5 milliohms	0.2 milliohms	1.30:1 max.	-55 dB at 2.0 to 3.0 GHz	0.2 dB max.
75 ohms			1.5 milliohms	2.0 milliohms				

Environmental

Nominal Impedance	Vibration: MIL-STD-202, Method 204	Shock: MIL-STD-202, Method 213	Thermal Shock: MIL-STD-202, Method 1071	Corrosion (Salt Spray): MIL-STD-202, Method 101	Moisture Resistance: MIL-STD-202, Method 106 5 min. after removal	Corona Level: 70,000 Feet
50 ohms	Test Condition B	Test Condition G	Test Condition B	Test Condition B	200 Megohms	375 Vrms
75 ohms						N/A

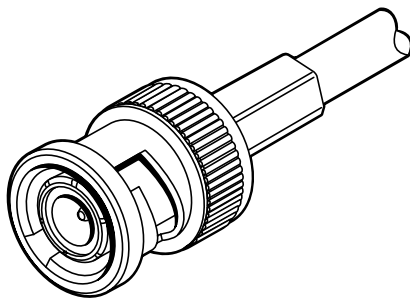

Straight Crimp/Crimp Plug

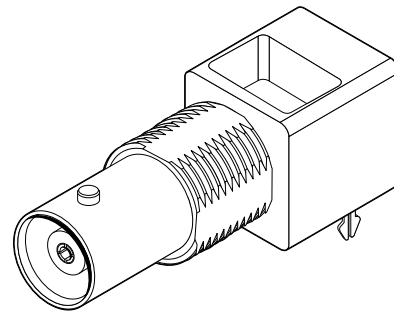

Right Angle PCB Jack Receptacle

BNC Connectors Plug Straight Crimp/Crimp

- Overall Plating: Nickel
- Center contact crimp or solder termination
- Crimp braid termination
- Packaging: Individual

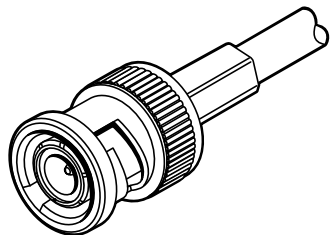

Order No.	Cable Group	Impedance	Center Contact	Assembly Instructions	Coupling Nut	Lead-free
73104-5003	RG58, 141, 303	50 ohms	Non-Captive	AS-73597-0032	Diecast	Yes
73174-0083			Captive	AS-73597-0042	Brass	
73174-0093						
73105-5003	RG59, 62, 71	75 ohms	Non-Captive	AS-73597-0032	Diecast	
73174-0113						

RF/Microwave Coaxial Products

BNC Connectors Plug Right Angle Solder/Crimp

- Overall Plating: Nickel
- Center contact solder termination
- Crimp braid termination
- Packaging: Individual

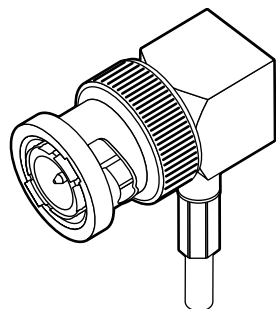

Order No.	Cable Group	Impedance	Assembly Instructions	Lead-free
73100-0015	RG58, 141, 303	50 ohms	AS-73597-0010	Yes
73100-0016	RG59, 62, 71	75 ohms		

BNC Connectors Jack Receptacle Vertical PCB

- Body: Brass
- Overall Plating: Nickel
- Packaging: Bag

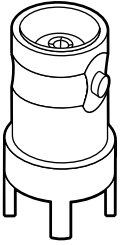

Order No.	Receptacle Height	Lead-free
73100-0153	21.10 (.831)	Yes
73100-0133	27.00 (1.063)	

BNC Connectors Jack Receptacle Vertical With Board Lock Pins PCB

- Body/Housing: Zinc
- Overall Plating: Nickel
- Packaging: Tray

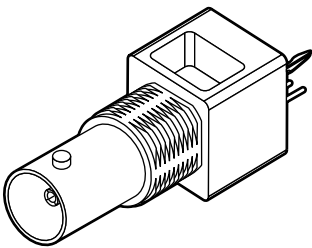

Order No.	Impedance	Lead-free
73101-0190	75 ohms	Yes

BNC Connectors Jack Receptacle Right Angle PCB

- Body/Housing: Zinc
- Overall Plating: Nickel

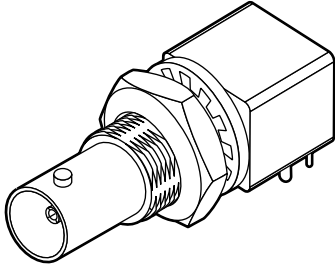

Order No.	Impedance	Board Lock Pins	Lead-free
73138-5033	50 ohms	Yes	Yes
73100-0080	75 ohms	No	
73101-0040			

RF/Microwave Coaxial Products

BNC Connectors Jack Receptacle Vertical Panel Isolated PCB

- Body: Zinc
- Housing: Valox
- Overall Plating: Nickel

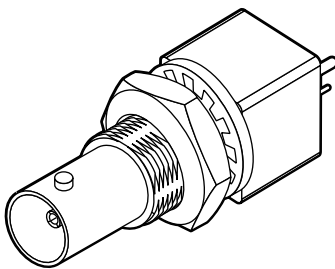

Order No.	Housing Color	Impedance	Lead-free
73131-5003	Black	50 ohms	Yes
73131-5013	White		
73131-7003	Black	75 ohms	

P

BNC Connectors Jack Receptacle Vertical Panel Isolated Filtered PCB

- Body: Zinc
- Housing: Valox
- Overall Plating: Nickel

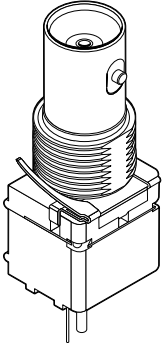

Order No.	Housing Color	Impedance	Lead-free
73101-0071	Black	75 ohms	Yes
73171-0440*		50 ohms	

*Hardware included

BNC Connectors Jack Receptacle Right Angle Panel Isolated PCB

- Body: Zinc
- Housing: Valox
- Overall Plating: Nickel
- Packaging: Tray

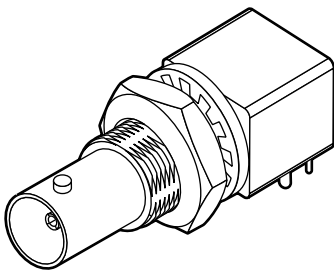

Order No.	Housing Color	Impedance	Lead-free
73138-5003	Black	50 ohms	Yes
73138-5013	White		
73138-0070	Black	75 ohms	
73138-0071	White		

BNC Connectors Jack Receptacle Right Angle Panel Isolated PCB

- Body: Zinc
- Housing: Valox
- Overall Plating: Nickel
- Packaging: Tray

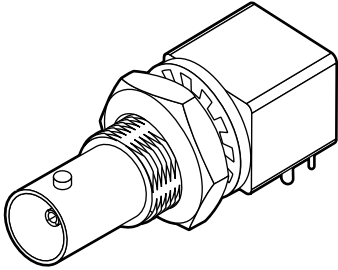

Order No.	Housing Color	Impedance	Lead-free
73100-0131*	White	50 ohms	Yes
73100-0167*	Black		
73137-5003		75 ohms	
73100-0067	White		
73100-0069			

* Board lock pins

RF/Microwave Coaxial Products

BNC Connectors Jack Receptacle Right Angle Filtered Panel Isolated With Board Lock Pins PCB

- Body: Zinc
- Housing: Valox
- Overall Plating: Nickel
- Packaging: Individual

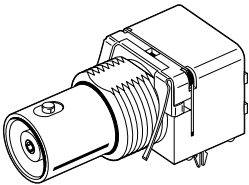

Order No.	Housing Color	Impedance	PCB Tail Length	Lead-free
73100-0090	Black	50 ohms	4.15 (.163)	Yes
73100-0162*			3.56 (.140)	
73100-0134				
73100-0223*				
†73100-0166†	Neutral	75 ohms	4.15 (.163)	
73101-0070	Black			

* Hardware included

† High temperature

BNC Connectors Jack Receptacle Low Profile Right Angle With Board Lock Pins PCB

- Body: Zinc
- Overall Plating: Nickel
- Packaging: Tray
- 0.500" height off PCB

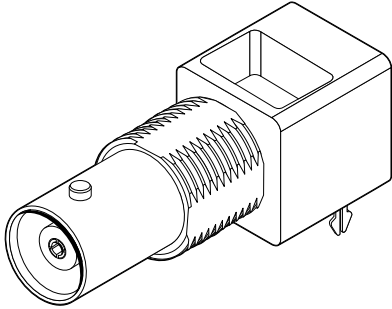

Order No.	Impedance	Lead-free
73101-0120	75 ohms	Yes
73171-0560*		
73171-2360	50 ohms	

* Round pins

BNC 50 Ohm Miniature Connectors

Right Angle PCB Jack Receptacle

- Packaging: Tray
- Narrow profile

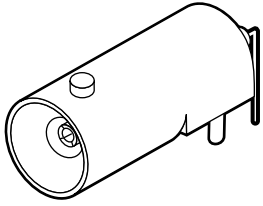

Order No.	Body	Plating
73100-0105	Zinc Alloy	Nickel
73100-0154		Tin

BNC 50 Ohm Isolated Bulkhead Mount Jack Receptacle Solder Pot

- Packaging: Individual
- Isolated from chassis

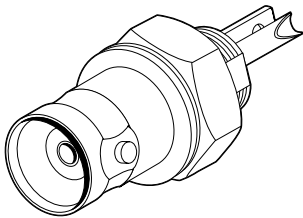

Order No.	Body	Plating
73115-5003	Brass	Nickel

RF/Microwave Coaxial Products

P

BNC 50 Ohm Bulkhead Mount Jack Receptacle Solder Pot

- Packaging: Tray

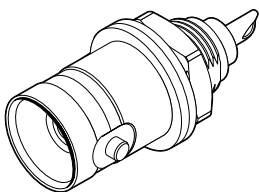

Order No.	Body	Plating
73100-0195	Brass	Nickel

BNC 50 Ohm Miniature Connectors

- Packaging: Tray

Bulkhead Mount Jack Receptacle Solder Pot

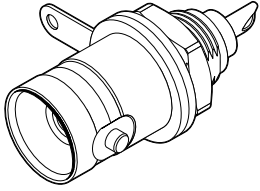

Order No.	Body	Plating
73119-5003	Brass	Nickel

BNC 50 Ohm

- Packaging: Tray

4 Hole Flange Jack Receptacle Solder Pot

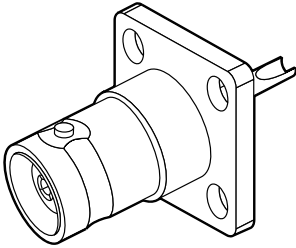

Order No.	Body	Plating
73124-5005	Brass	Nickel

BNC 50 Ohm

- Packaging: Tray

Adapter Right Angle Plug/Jack

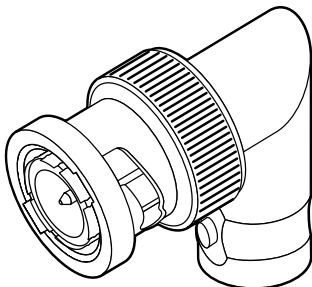

Order No.	Body	Plating
73151-5003	Zinc Alloy	Nickel

BNC 50 Ohm Miniature Connectors

- Packaging: Tray

Adapter
"T"
Jack/Plug/Jack

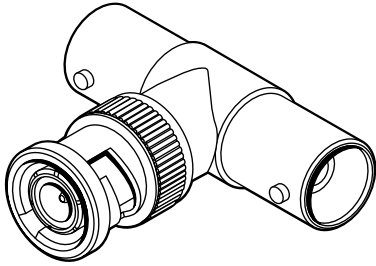

Order No.	Body	Plating
73148-5003	Zinc Alloy	Nickel

RF/Microwave Coaxial Products

BNC 50 and 75 Ohm Commercial Connectors

Jack Receptacle
Right Angle
Low Profile
PCB

- Die cast Zinc alloy
- Ultra low profile
- Board lock pins
- Special knurled nut
- Packaging: Tray

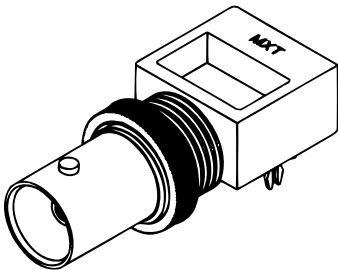

Order No.	Body	Plating	Impedance
73171-0700	Zinc Alloy	Nickel	75 ohms

P

SMP Subminiature Connectors

PCB
Cable
Panel
Adapters

Features and Benefits

- Subminiature
- Push-on or snap coupling
- DC to 40 GHz
- Small Size
- Up to .020" radial mis-alignment

The SMP series subminiature connectors offer superior performance from DC to 40 GHz. PCB mount, cable mount and in-series adapters provide an interconnect solution for board-to-board, blind mate and rack and panel applications while maintaining package density.

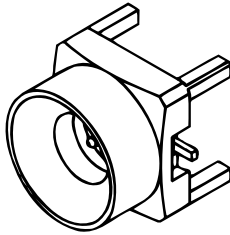

Plug

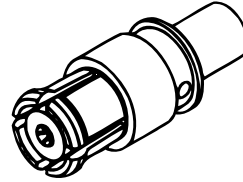

Jack

Typical Specifications

Electrical

Nominal Impedance (Ohms)	Frequency Range (GHz)	Voltage, Working (Vrms)	Insulation Resistance (Megohms)	Center Contact Resistance (milliohms)	Outer Contact Resistance (milliohms)	RF Leakage (-dB)	RF Insertion Loss (dB)	VSWR at Max. Freq
50	DC-40	335	5000	≤ 6	≤ 2	65	≤.1 at 1GHz	1.50

Mechanical

Coupling Method	Force to Engage (max)	Force to Disengage	Durability (Cycles)
Push-on	3.38 lbs	1.80 lbs	500

Environmental

Temperature (Degrees C)	Vibration: MIL-STD-202, Method 204	Thermal Shock: MIL-STD- 202, Method 107	Corrosion (Salt Spray): MIL-STD-202, Method 101	Mechanical Shock: MIL-STD-202, Method 213	Moisture Resistance: MIL-STD-202, Method 106
-65 to +165	Test Condition B	Test Condition C	Test Condition B	Test Condition B	Five minutes after removal 200 Megohms

SMP Microminiature Connectors

Plug
Vertical
PCB

- Insulator: TFE
- Catchers with lead-in chamfer
- Packaging: Tape and reel

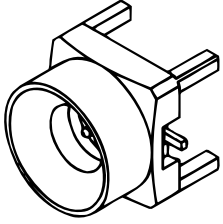

Order No.	Detent	Body	Plating
73415-3310	Limited	Brass	Gold
73415-3320	None		

Adapter Jack to Jack

- Insulator: TFE
- Packaging: Tray

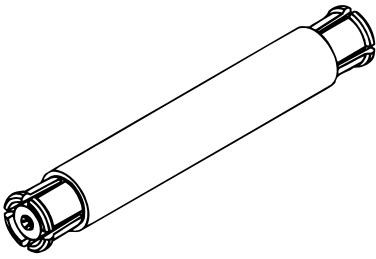

Order No.	Body	Plating
73415-3350	Beryllium Copper	Gold
73415-3020		

RF/Microwave Coaxial Products

P

Jack Right Angle Cable

- Direct solder attach
- Packaging: Individual

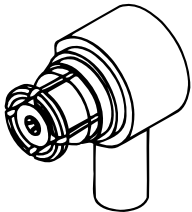

Order No.	Cable	Body	Plating	Assembly Instructions
73415-3030	.086 SR	Beryllium Copper	Gold	AS-89678-7600
73415-3580	.047 SR			
73415-3720	UT-47-TP			

SMP Microminiature Connectors

- Direct solder attach
- Insulator: TFE
- Packaging: Tray

Jack Straight Cable

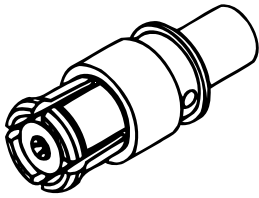

Order	No. Cable	Body	Plating	Assembly Instructions
73415-3740	UT-85-TP	Beryllium Copper	Gold	AS-89678-8560

SMP Subminiature

- Insulator: TFE
- Packaging: Tray

Plug Edge Mount

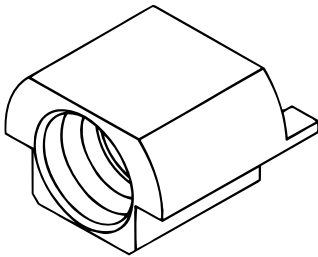

Order No.	Body	Plating	Detent
73415-3590	Brass	Gold	Limited
73415-5720			Full
73415-5740			Smooth Bore

SMP Subminiature

- Insulator: TFE
- Packaging: Tape and reel

Plug Vertical Surface Mount

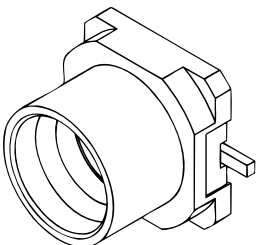

Order No.	Body	Plating	Detent
85305-0232	Brass	Gold	Limited
73415-3810			Smooth Bore